

Cylindrical Heat & Heat/Cool
For Extrusion Machines

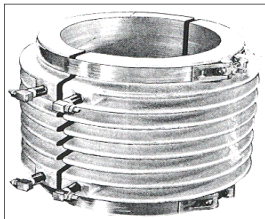

Finned for Air Cool
Extrusion Machines

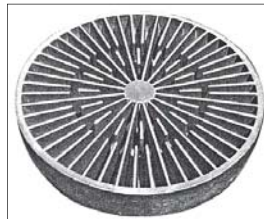

Special for Your
Heating Requirements

HOLES, CUTOUTS AND
THERMOWELLS AVAILABLE.

JUST SPECIFY SIZE AND LOCATION.

CUSTOMIZED TO YOUR APPLICATION.



Protective Housing Options

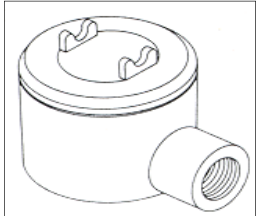

Explosion Proof Box
OPTION 1

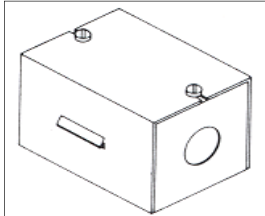

Sheet Metal Box
OPTION 2

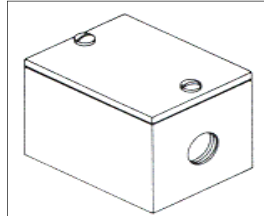

Cast In Box
OPTION 3

Electrical Termination

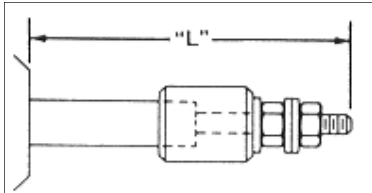

ET TYPE 1
Ceramic Insulated
10-32 Screw Terminal
(Other Types Available)

Cooling Tube Terminations

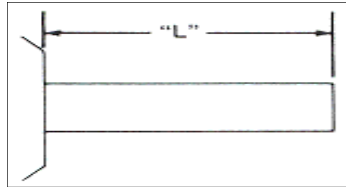

CT TYPE 1
Plain

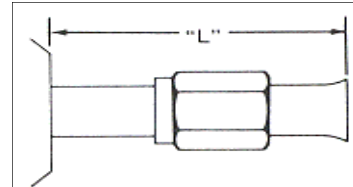

CT TYPE 2
37° Flare Nut Fitting

(OTHER TYPES AVAILABLE)

Cylindrical Heat & Cool

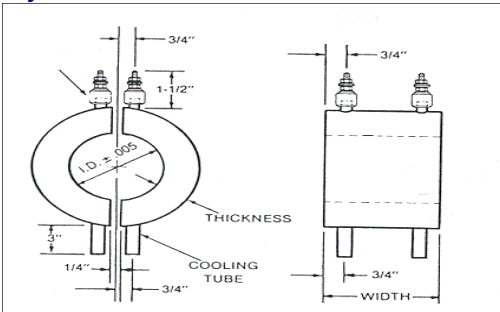

Cylindrical Heat with Fins

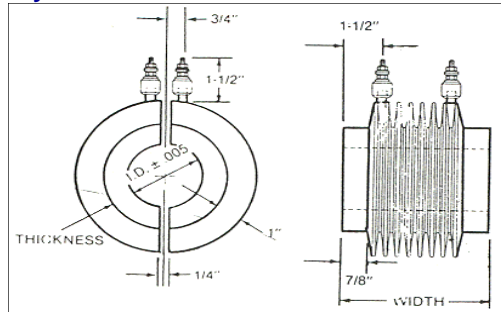

TO PLACE AN ORDER, PLEASE SPECIFY:

- **CAST DESIGN.** PLEASE SUPPLY A COMPLETE DRAWING WHICH SHOWS ALL DIMENSIONS AND CRITICAL TOLERANCES. ALSO, **INCLUDE SIZE AND LOCATION OF ANY HOLES, CUTOUTS OR THERMOWELLS.** REFER TO REFERENCE DIMENSIONS AND SPECIFICATIONS ABOVE.
- **EXIT LOCATIONS** OF HEATER ELEMENT AND COOLING TUBE (IF REQUIRED)
- **ELECTRICAL TERMINATIONS AND HOUSINGS;** TYPE S IS STANDARD
- WATTAGE AND VOLTAGE RATINGS
- ALUMINUM OR BRONZE
- QUANTITY

TEVAC
TUBULAR BAND HEATERS
CUSTOM DESIGNS AVAILABLE

Tevac Part Number	I.D.	Width	Volts	Watts	4 Hole
TBH-3A1JB-Z	3	1-1/2	240V	450W	Yes
TBH-3A1JB-Z1	3	1-1/2	240V	600W	Yes
TBH-2A1AB-Z	2	1	240V	400W	No
TBH-5A2AB-Z	5	2	240V	1150W	No
TBH-5A2JB-Z	5	2-1/2	240V	1150W	No
TBH-2J1JB-Z	2-1/2	1-1/2	240V	500W	No
TBH-4N2EB-Z	4-3/4	2-1/4	240V	550W	No
TBH-4J1JB-Z	4-1/2	1-1/2	240V	600W	Yes

Hose with Female NPT Fitting
 (order separately)

Tevac Part Number	Hose Length
TBH-24-hose	24"
TBH-36-hose	36"
TBH-48-hose	48"

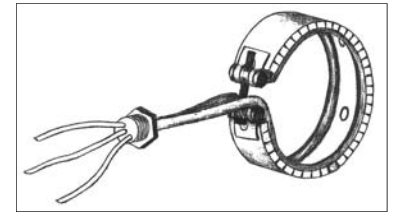

52" Leads with Ground Wire Standard
 Ultra Rugged Design
 Removable Flex Hose over Lead (order separately)
 Available with or without Holes
 Stainless Steel Sheath
 Incoloy Elements
 Nut Silver Soldered to Tubular Element
 Order Hose Separately to Save Money
 Available in 120V or 240V
 Contamination Proof
 4 Holes 90° apart

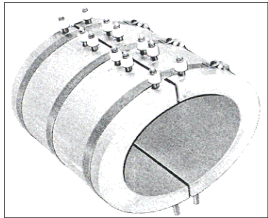

Cylindrical Heat & Heat/Cool
 For Extrusion Machines

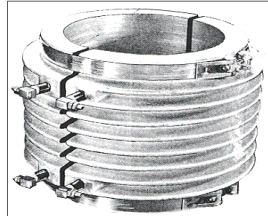

Finned for Air Cool
 Extrusion Machines

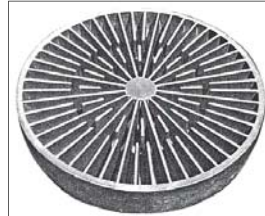

Special for Your
 Heating Requirements

TEVAC
CAST HEATERS
ALUMINUM OR BRONZE

HOLES, CUTOUPS AND
 THERMOWELLS AVAILABLE.
 JUST SPECIFY SIZE AND LOCATION.

To place an order, please specify:

- 1- **Cast Design.** Please supply a complete drawing which shows all dimensions and critical tolerances. **Also, include size and location of any holes, cutouts or thermowells.** Refer to reference dimensions and specifications below.
- 2 - **Exit locations** of heater element and cooling tube (if required)
- 3 - **Electrical terminations and housings,** Type S is standard
- 4 - **Wattage and voltage ratings**
- 5 - **Aluminum or bronze**
- 6 - **Quantity**

Protective Housing Options

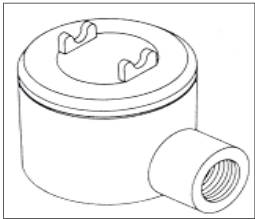

Explosion Proof Box
H1

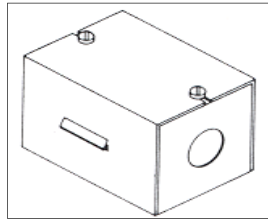

Sheet Metal Box
H2

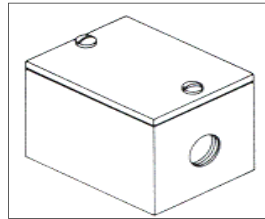

Cast In Box
H3

Electrical Termination

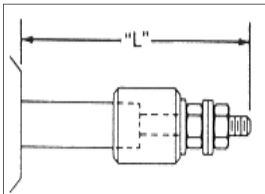

Type E1
 Ceramic Insulated
 10-32 Screw Terminal
 (Other Types Available)

Cooling Tube Terminations

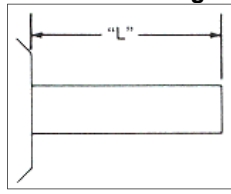

Type C1
 Plain Tube

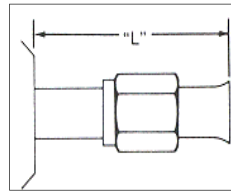

Type C2
 37 deg. Flare Nut Fitting
 (OTHER TYPES AVAILABLE)

Cylindrical Heat & Cool

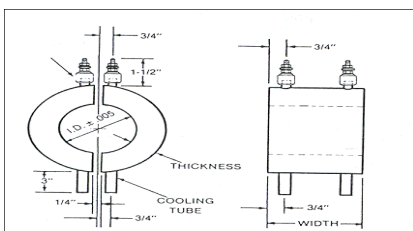

Cylindrical Heat with Fins

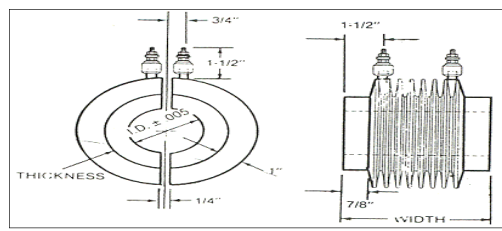

SUPERIOR QUALITY * QUICK DELIVERY * CALL FOR PRICE